



By **Wi-Ex**.com

zBoost YX545 SOHO User Guide



30 day money back guarantee when you buy directly from Wi-Ex®. If product is purchased from a reseller or third party, you must use their return policy.

1 Year Manufacturer Warranty. Register your zBoost® product at www.Wi-Ex.com

About zBoost® from Wi-Ex®

Wi-Ex® is the leader in cell phone signal boosters. zBoost® enhances the performance of your cell phone, PDA and wireless data card.

Compatibility – Dual Band zBoosts are compatible with 800MHz and 1900MHz regardless of technology- including CDMA and GSM.

Patented technologies protect the carrier network.

1-year manufacturer warranty – register your product at www.Wi-Ex.com.

zBoost® products have more awards, more sales and more locations than all other signal boosters ...COMBINED.

FCC Information

FCC ID: SO4YX545-PCS-CEL

Warning: Changes or modifications to this device not expressly approved by Wi-Ex® could void the user's authority to operate the equipment.

Note: This equipment has been tested and found to comply with the limits for a Class B digital device, pursuant to Part 15 of the FCC Rules. These limits are designed to provide reasonable protection against harmful interference in a residential installation. This equipment generates, uses, and can radiate radio frequency energy and, if not installed and used in accordance with the instructions, may cause harmful interference to radio communications. However, there is no guarantee that interference will not occur in a particular installation. If the equipment does cause harmful interference to radio or television reception, which can be determined by turning the equipment off and on, the user is encouraged to try to correct the interference by one or more of the following measures:

- Reorient or relocate the receiving antenna
- Increase the separation between the equipment and receiver
- Connect the equipment to an outlet on a circuit different from that to which the receiver is connected
- Consult the dealer or an experienced radio/TV technician for help

This equipment complies with FCC radiation exposure limits set forth for an uncontrolled environment. This transmitter must not be co-located or operating in conjunction with any other antenna or transmitter. In accordance with FCC requirements of human exposure to radiofrequency fields, the radiating element (antenna) shall be installed such that a minimum separation distance of 20cm (8in) is maintained from all persons.

Industry Canada Regulations

IC ID: 5544A-YX545PCSEL

This Class B digital apparatus meets all requirements of the Canadian Interference Causing Equipment Regulations. Operation is subject to the following two conditions: (1) this device may not cause harmful interference, and (2) this device must accept any interference received, including interference that may cause undesired operation.

The term "IC:" before the radio certification number only signifies that Industry Canada technical specifications were met.

RF Exposure:The manufacturer's rated output power of this equipment is for single carrier operation. For situations when multiple carrier signals are present, the rating would have to be reduced by 3.5 dB, especially where the output is re-radiated and can cause interference to adjacent band users. This power reduction is to be by means of input power or gain reduction and not by an attenuator at the output of the device.

Cet appareillage numérique de la classe [B] répond à toutes les exigences de l'interférence canadienne causant des régléments d'équipement. L'opération est sujette aux deux conditions suivantes: (1) ce dispositif peut ne pas causer l'interférence nocive, et (2) ce dispositif doit accepter n'importe quelle interférence reçue, y compris l'interférence qui peut causer l'opération peu désirée.

Le fabricant nominale de la puissance de sortie de ce matériel est simple transporteur. Pour les situations lorsque plusieurs signaux porteurs sont présents, l'évaluation devrait être réduite de 3.5 dB, en particulier lorsque le signal de sortie est ré-émission et peut provoquer des interférences adjacentes à la bande utilisateurs. Ce pouvoir est de la réduction par le biais de la sortie d'alimentation ou la réduction de gain et non par un atténuateur à la sortie du dispositif.

Please note: This unit has been approved for use in Canada under RSS 131, however, consent for the use of this device to improve cellular or PCS coverage, must be obtained through your cellular or PCS provider, prior to placing the unit in operation. Please refer to the Industry Canada document CPC 2-1-05, Section 6.1 available or viewable at:

<http://www.ic.gc.ca/epic/site/smt-gst.nsf/en/sf08942e.html>

Safety and Product Warranty Information

Copyright Notice

This manual is copyrighted. All rights reserved. This manual, whole or in part, may not be copied, photocopied, reproduced, translated or reduced to any electronic medium or machine readable form for distribution. This manual whole or in part, may not be modified without prior consent, in writing, from Wireless Extenders.

Copyright © 2010 by Wireless Extenders, Inc.

Trademarks

Wireless Extenders, Wi-Ex, the Wi-Ex logo, zBoost, the zBoost logo and Extending Cell Zones are registered trademarks of Wireless Extenders, Inc.

Safety Guidelines

In accordance with FCC requirements of human exposure to radiofrequency fields, the radiating element (antenna) shall be positioned such that a minimum separation distance of 8 inches (20cm) is maintained between the radiating element and the user and/or general population.

Limited Liability

In no event shall Wireless Extenders be liable for any direct, indirect, special, punitive, incidental, exemplary or consequential damages, or any damages, whether in an action under contract, negligence, or any other theory, arising out of or in connection with the set up of, use of, inability to use, or performance of the information, services, products, and materials available from this manual. These limitations shall apply notwithstanding any failure of essential purpose of any limited remedy. Because some jurisdictions do not allow limitations on how long an implied warranty last, or the exclusion or limitation of liability for consequential or incidental damages, the above limitations may not apply to you. For full warranty guidelines, see page 15.



Note

Changes or modifications not expressly approved by Wi-Ex® could void the user's authority to operate this equipment and/or void the product warranty.

Package Contents: zBoost® YX545 SOHO

Before you begin, make sure all of the following parts came with your zBoost® YX545.

Literature Contents:

- ① Set-up overview for zBoost® YX545 SOHO (User Guide online only)

Product Contents:

- ② zBoost® Base Unit
- ③ zBoost® Base Unit Antenna
- ④ Power Supply
- ⑤ RG-59 (mini) Coax Cable 50 ft.
- ⑥ Signal Antenna
- ⑦ Signal Antenna Mounting Hardware

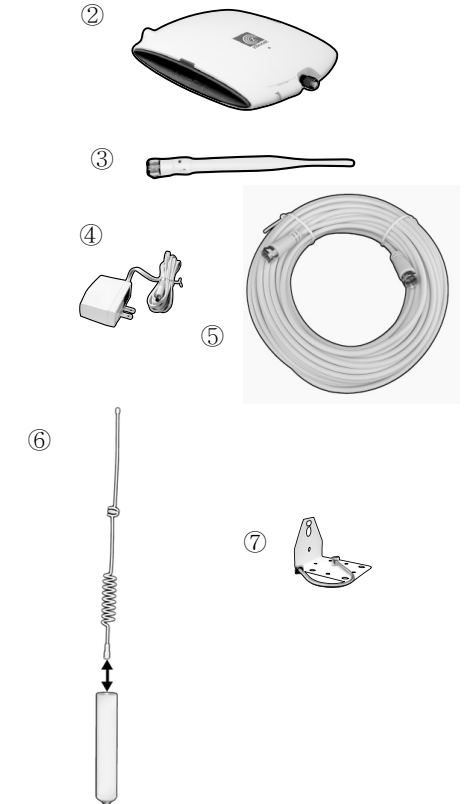

Optional zBoost® Accessories

The following accessories are available to improve signal reception and provide increased coverage in your home or office. Please see our website for complete selection.

To order, call 1-800-871-1612 or visit, www.Wi-Ex.com

YX545-Dual Band	Part #	Description
Most Popular Accessory for YX545 SOHO:		
X	YX039-PCS-CEL	Bi-Directional receiving Signal Antenna upgrade (13 dBi PCS / 8 dBi CEL)
Other Accessories:		
X	YX012	Outside Grounding Kit
	YX021-CEL	Directional receiving Signal Antenna upgrade (8 dBi)
	YX022-CEL	Omni-Directional receiving signal antenna upgrade (6 dBi)
	YX023-PCS	Directional receiving Signal Antenna upgrade (13 dBi)
	YX024-PCS	Directional transmitting Base Unit Antenna upgrade (7 dBi)
	YX026-CEL	Directional receiving Signal Antenna upgrade (11 dBi)
X	YX027-PCS-CEL	Directional transmitting Base Unit Antenna upgrade (9 dBi PCS / 6 dBi CEL)
X	YX028-PCS-CEL	Directional transmitting window-mount Base Unit Antenna upgrade (9 dBi PCS / 6 dBi CEL)
X	YX030-15W	15 ft. Signal Antenna coax extension, low-loss RG-6
X	YX030-35W	35 ft. Signal Antenna coax extension cable, low-loss RG-6
X	YX031-10W	10 ft. Base Unit Antenna coax extension cable
X	YX030-08W	8" flat window entry cable
X	YX050-PCS-CEL	Omni-Directional transmitting ceiling-mount Base Unit Antenna (2 dBi PCS / 1 dBi CEL)
	YX055-CEL	CEL Directional Outdoor Yagi Antenna (15 dBi)

Table of Contents

About zBoost® from Wi-Ex®i
 FCC Information..... i
 Industry Canada Regulations i
Safety and Product Warranty Informationii
 Copyright Notice..... ii
 Trademarks ii
 Safety Guidelines ii
 Limited Liability ii
Package Contents: zBoost® YX545-PCS-CEL..... iii
Optional zBoost® Accessories iv
Table of Content1
Overview.....2
 Why Indoor Signals Can Be Weak 2
Preparing to Set Up Your zBoost® Product3
 Tools Needed 3
 Check for Signal Strength 3
 Determine the Needed Coverage Area..... 4
 Determine the Location of Signal Antenna and Base Unit Antenna 4
 Additional Cable Requirements 5
 Securing Cable with a Drip Loop..... 5
 Power Requirements 5
Setting Up Your zBoost® Signal Booster6
 Placement of the Signal Antenna..... 6
 Easiest Set-Up 6
 Better Performance..... 7
 Best Performance 8
 Positioning the Base Unit..... 10
 Confirm That Your zBoost® is Working Properly 10
Improving Your Coverage Area 11
zBoost® Base Unit Light Indicators 12
YX545-SOHO Technical Specifications 13
Frequently Asked Questions 14
zBoost® Warranty Information.....15&16

Overview

Thank you for choosing zBoost®. You will now be able to use your cell phone INSIDE your home or office. Gone are the days when you had to go to the window upstairs or walk outside to use your cell phone. Like a skylight that brings sunlight into your home, zBoost® transports and amplifies the outdoor cellular signals into your home or office.

By following the easy instructions in this user guide, you will be Extending Cell Zones™ into your home or office.

Why Indoor Signals Can Be Weak

There are several obstacles that can contribute to the poor reception you receive in your home or office:

1. Location of the Cell Phone Tower in Relation to Your Home/Office

While cell phone providers have tried to place cell phone towers to provide the best overall coverage, local ordinances and terrain features can impose restrictions on where these towers can be placed, thus, limiting the signal strength available at your location.

2. Obstructions Caused by Buildings, Terrain and Trees

Cell phone signals can be completely blocked or reflected by buildings, walls, trees, hills and other terrain features resulting in low signal strength.

3. Energy Efficient Windows

These new windows can also affect signal penetration into the house

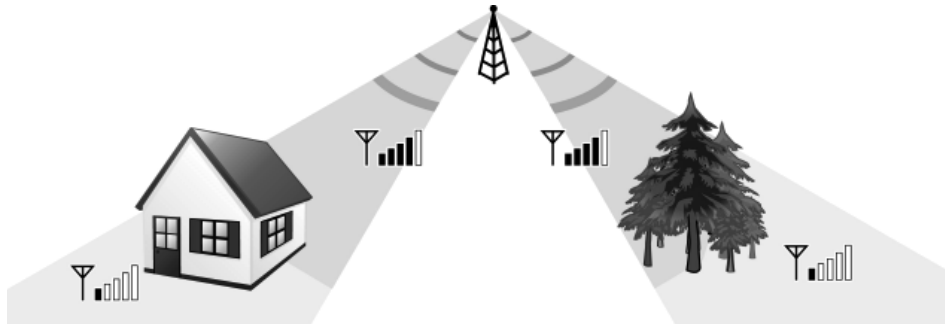

Preparing to Set Up Your zBoost® Product

Tools Needed

The following tools are needed to set up zBoost®:

- #2 Philips screwdriver
- Cellular phone operating in the band supported by your zBoost® unit
- Drill (may be required for outdoor or attic antenna placement)

Check for Signal Strength

Before placing a zBoost® in your home, make sure that you can place calls on the outside of your home, in the attic, at roof level or wherever you plan to place the signal antenna. zBoost® can only bring signal into your home when signal reaches the Signal Antenna. If there is no signal, the zBoost® will not work for you.

Using your cell phone, place a call from an outdoor location to confirm that enough signal is present to complete the call. If a weak signal is available at ground level, check the signal strength in your attic or at roof level location where the signal will likely be stronger and where the Signal Antenna can be placed for best performance.

If you can reliably make and receive calls outside your home, then zBoost® can bring the signal into your home.

If only one signal bar is displayed on your cell phone outside, indoor coverage will be limited to one small room. We recommend placing the Signal Antenna outside and/or purchasing a Wi-Ex® upgrade Signal Antenna for increased coverage (see page iv).



! Note

Cell phone signal bars are approximate and vary from phone to phone. The number of bars can fluctuate widely, depending on the location of the phone, the position or angle of the phone, weather, etc. Most cell phone signal meters update every 6 to 10 seconds. An increase of only one bar typically indicates a 4x to 10x signal increase.

Determine the Needed Coverage Area

Identify the location in your home/office where you need signal coverage the most. The zBoost® YX545 SOHO can cover up to 2500 square feet (coverage varies based on outdoor signal level, building construction, and placement of antennas). Walls, ceilings or floors will reduce the coverage area.

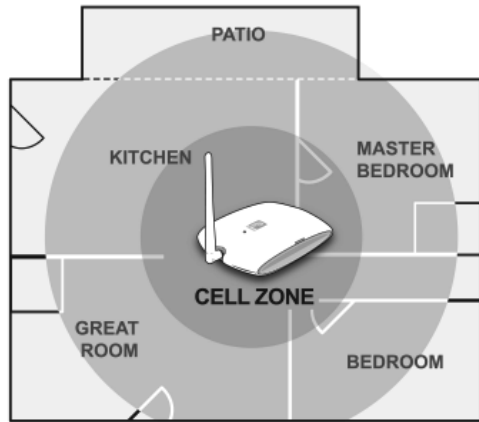

Determine the Location of Signal Antenna and Base Unit Antenna

It is recommended that the Signal Antenna and Base Unit Antenna have at least 15 feet of vertical separation.

If the antennas are too close together, the light on the Base Unit will flash red, indicating a problem see the Light Indicators section (Page 12). To capture the best signal, place the Signal Antenna as high as possible and position it vertically, keeping it at it at least 2 feet away from any metal.

The location of the Signal Antenna should be at least 15 feet higher than the Base Unit Antenna. If this is not possible, maximizing the horizontal separation between the 2 antennas is advised.

See page 6, Setting Up Your zBoost® Product, for additional information.

Antenna Bracket Assembly

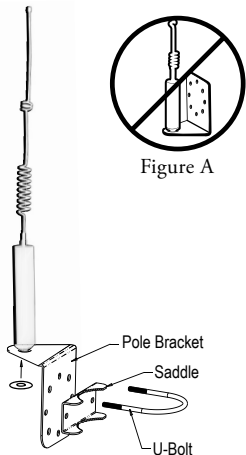

IMPORTANT: Incorrectly mounting the Signal Antenna to the mounting bracket (see figure A) will impede performance. Ensure that the Signal Antenna is properly positioned in the mounting bracket as pictured below.

To mount antenna to a pole: Attach bottom of antenna to pole bracket as pictured. Use U-Bolt to secure bracket to pole and fasten.

To mount antenna to a flat surface: Attach bottom of antenna to pole bracket as pictured. Secure bracket to desired surface using provided screws. Use of the Saddle and U-Bolt are not necessary for this option.

Additional Cable Requirements

If the distance between the Signal Antenna and the Base Unit exceeds 50 feet, extension cables are available on our website or at many home improvement and electronic stores. The included cable is RG59-mini. For better performance, you may replace it with RG-6 cable for satellite TV.

The total cable length should not exceed 70 feet unless you also purchase an upgraded signal antenna (see page iv). A longer cable is helpful only if it allows you to place the Signal Antenna in a location where you measure stronger signal.



Note

Avoid placing the Signal Antenna near metal such as wiring, A/C ducts, metal siding, truss plates, etc. When connecting the cable to the antenna, run the cable straight down from the antenna. Avoid draping the coax near the antenna.

Grounding the Signal Antenna

If you decide to place the Signal Antenna outdoors, it must be properly grounded. (See page iv for a recommended grounding kit).

The set up must be in accordance with Article 810 of the National Electric Code (NEC). A listed antenna discharge unit must be provided for the lead-in coaxial cable per NEC article 8.10.20 or the shield of the coaxial cable must be permanently and effectively grounded in accordance with NEC article 8.10.21. Please consult a professional installer or electrician for more information. (See page iv).

Securing Cable with a Drip Loop

If you place the Signal Antenna outdoors, create a drip loop with the coaxial cable at the point where the cable enters the building through an outside wall. This can be done by twisting and securing the cable into a loop (no less than 4" across) near the entry point. This will help prevent moisture from gathering at entry point and leaking into the building. Consult a professional installer if you need more information.

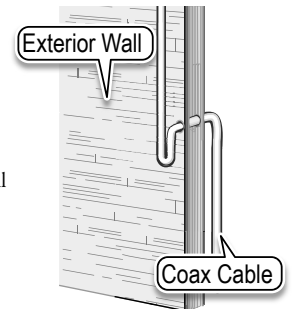

Power Requirements

The Base Unit can be plugged into a standard 2 or 3 prong 110 VAC receptacle using the Included power supply. The power supply consumes less than 10W (less than 0.2A).



Note

The zBoost® YX545 SOHO base unit MUST only be used with the provided power adaptor. Use of other power adaptors will void the warranty and may damage the unit. Use of other equipment is not FCC approved.

Setting Up Your zBoost® Signal Booster

Placement of the Signal Antenna

Choosing the best location for the Signal Antenna provides the best performance and the largest area of improved signal. Determine the location that provides the strongest signal using the signal strength indicator on your cell phone. Find the location that provides the most bars of signal strength and place the Signal Antenna at or near that location. Assemble the Signal Antenna mounting bracket as shown on page 4. Avoid placing the Signal Antenna near metal such as wiring, A/C ducts, metal siding, truss plates, etc. When connecting the cable to the antenna, run the cable straight down from the antenna. Avoid draping the coax near the antenna.

Choose 1 of the following 3 options for setting up your zBoost® system:

① EASIEST: Inside, by a window

Locate a window where you get service.

1. Mount the Signal Antenna above the window. The coverage your zBoost® provides is largely determined by the quality of signal received by the Signal Antenna.
2. Assemble the Base Unit Antenna. Place the Base Unit in desired location – where you want to create a Cell Zone™ (15 feet of vertical separation between the Base Unit and Signal Antenna is recommended). Connect the Base Unit Antenna to the Base Unit and place it where you need signal.
3. Attach the coaxial cable to the Signal Antenna.
4. Connect the other end of the coaxial cable to the Base Unit.
5. Attach the Base Unit Antenna to the Base Unit and position it vertically.
6. Connect the Power Supply to the Base Unit and plug into a power outlet.

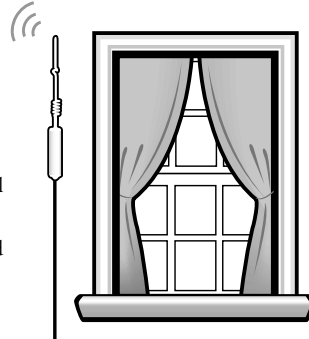

Easiest Set-up
Place Signal Antenna
inside, by a window

NOTE: The zBoost® YX545 SOHO requires at least 15 feet of vertical separation between the Base Unit and the Signal Antenna. Generally, increasing this distance (up to 40 feet) will increase the performance and decreasing the distance will limit zBoost® performance. (If 15 feet of separation is not possible, you may try our new METRO model, which was designed for lofts and urban dwellings and requires no vertical separation.) Keep the Base Unit off the floor and at least 2 feet away from other cords, metal objects or other wireless devices such as wireless routers or wireless access points. The zBoost® SOHO performs best when there are no obstructions between the zBoost® Base Unit and your mobile device.

Upon initial power up, a solid GREEN light should appear indicating normal conditions. If a RED light appears, adjustments may be needed to optimize performance. If you find the increased signal coverage is acceptable, however, no additional adjustments are needed. See Light Indicator section (Page 12) for more information.

② BETTER PERFORMANCE: Outside of a window

Locate a window where you get signal.

1. Mount the Signal Antenna outside of the window. The coverage your zBoost® provides is largely determined by the quality of signal received by the Signal Antenna.
2. Assemble the Base Unit Antenna. Place the Base Unit in desired location – where you want to create a Cell Zone™ (15 feet of vertical separation between the Base Unit and Signal Antenna is recommended).
3. Attach the coaxial cable to the Signal Antenna.
4. Run the coaxial cable from the Signal Antenna through the window (an optional window entry kit is available: see page iv) and to the Base Unit.
5. Attach the Base Unit Antenna to the Base Unit and position it vertically.
6. Connect the Power Supply to the Base Unit and plug into a power outlet.

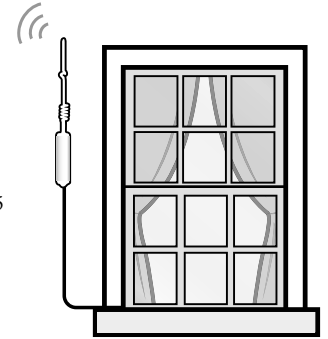

Better Performance
Place Signal Antenna
outside of window*

NOTE: The zBoost® SOHO requires at least 15 feet of vertical separation between the Base Unit and the Signal Antenna. Generally, increasing this distance (up to 40 feet) will increase the performance and decreasing the distance will limit zBoost® performance. (If 15 feet of separation is not possible, you may try our new METRO model, which was designed for lofts and urban dwellings and requires no vertical separation.) Keep the Base Unit off the floor and at least 2 feet away from other cords, metal objects or other wireless devices such as wireless routers or wireless access points. The zBoost® SOHO performs best when there are no obstructions between the zBoost® Base Unit and your mobile device.

Upon initial power up, a solid GREEN light should appear indicating normal conditions. If a RED light appears, adjustments may be needed to optimize performance. If you find the increased signal coverage is acceptable, however, no additional adjustments are needed. See Light Indicator section (Page 12) for more information.

*An 8 inch window entry cable may be needed for this option. It is available for purchase at www.Wi-Ex.com (Part #: YX030-08W).

③ BEST PERFORMANCE: Attic/Outdoor placement

The following instructions are recommended for the best reception:

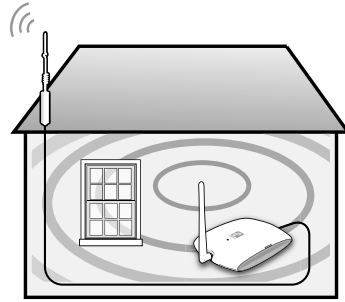

Best Performance
Place Signal Antenna on roof or in attic

- Using your cell phone as a signal meter, confirm that either your attic or your roof will deliver optimal signal strength to the Signal Antenna. Identify the best location for attachment of the mounting bracket – such as an attic cross or main beam. The coverage your zBoost® provides is largely determined by the quality of signal received by the Signal Antenna.
- Secure the mounting bracket at the highest possible point and at least 3 feet (1 meter) away from metal objects such as pipes, metal siding, A/C unit etc).
- Position the mounting bracket such that the Signal Antenna will be vertical and attach the Signal Antenna. See page 4 for more information.
- Connect the supplied coaxial cable to the base of the Signal Antenna. Run the coaxial cable along a descending pipe or through a wall that leads closest to the location of the Base Unit. Use the provided 50 feet of RG-59(mini) coaxial cable to connect the Signal Antenna and the Base Unit. Should you need additional cable length, 15 foot extensions (Part #: YX30-15w) are available at www.Wi-Ex.com. Please note: Cable longer than 75 feet is not recommended.

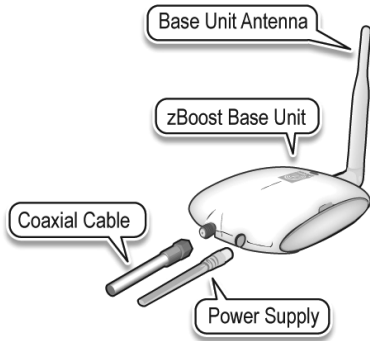

NOTE: Refrain from securing cable or drilling holes until the system has been tested.

- From the other end, connect the coax cable to the Base Unit. Assemble the Base Unit Antenna. Connect the Base Unit Antenna to the Base Unit and place it where you need signal. Place the zBoost® Base Unit where you want to create a Cell Zone. For the widest possible signal area, it is recommended that you position the Base Unit near the middle of a room or mount it on an interior wall. This Base Unit uses an omni-directional antenna that delivers signal in a circular pattern around the antenna.
- Connect the zBoost® Base Unit to the provided power supply and plug into a power outlet. When your zBoost® system is in place and fully connected, walk throughout your home or office and verify that you are able to reliably place calls. If the signal strength has improved, your zBoost® is working. Remember, coverage varies based on outdoor signal level, building construction, and antenna placement. Coverage in adjoining rooms (next to, above, or below) will be reduced by walls and ceiling/floors.

NOTE: The zBoost® YX545 SOHO requires at least 15 feet of vertical separation between the Base Unit and the Signal Antenna. Generally, increasing this distance (up to 40 feet) will increase the performance and decreasing the distance will limit zBoost® performance. (If 15 feet of separation is not possible, you may try our new METRO model, which was designed for lofts and urban dwellings and requires no vertical separation.) Keep the Base Unit off the floor and at least 2 feet away from other cords, metal objects or other wireless devices such as wireless routers or wireless access points. The zBoost® SOHO performs best when there are no obstructions between the zBoost® Base Unit and your mobile device.

Upon initial power up, a solid GREEN light should appear indicating normal conditions. If a RED light appears, adjustments may be needed to optimize performance. If you find the increased signal coverage is acceptable, however, no additional adjustments are needed. See Light Indicator section (Page 12) for more information.

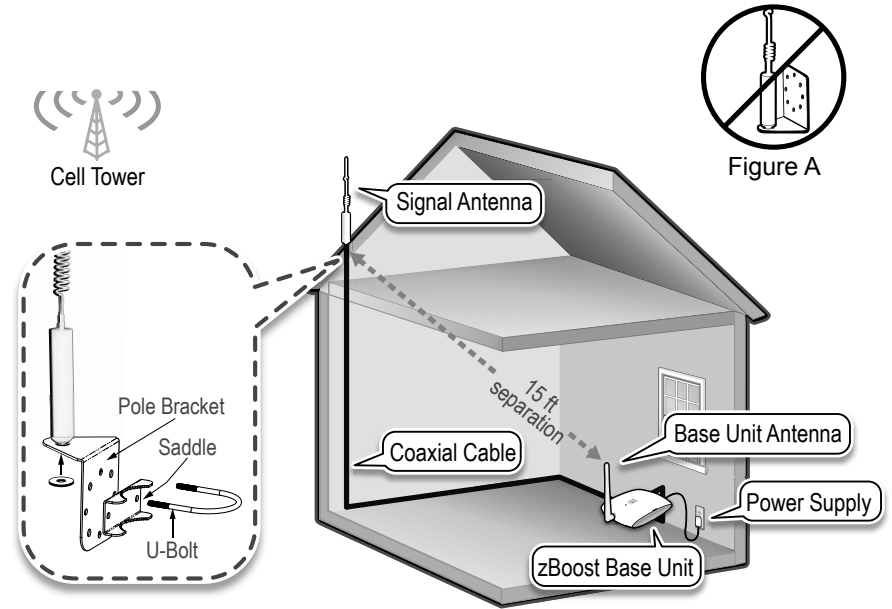

Figure A

Positioning the Base Unit

For the widest possible signal area, it is recommended that you position the zBoost® YX545 SOHO Base Unit near the middle of a room or mount it on an interior wall. This Base Unit uses an omni-directional antenna that delivers signal in a circular pattern around the antenna.

If you decide to position the Base Unit on or near an outside wall, we recommend purchasing a Directional Base Unit Antenna (Page iv) to focus the signal in the direction of your choice.

The Base Unit can be mounted either directly on a wall or placed on a flat surface (e.g., a bookshelf, desk, end table, etc.). The Base Unit performs best when located at least 4 feet above the floor or approximately the height of a cell phone when it is typically in use (avoid placing the Base Unit on the floor).

For best results, avoid placing the Base Unit antenna within 2 feet of other cords, metal objects or other wireless devices such as wireless routers or wireless access points.

Confirm That Your zBoost® is Working Properly

Perform the following steps to confirm that the unit is now working properly:

1. Unplug the Base Unit power cord.
2. Turn on your cell phone and check the signal meter.
3. Plug the power cord into the Base Unit.
4. Hold your cell phone about 5 feet from the Base Unit and then turn it on. Wait up to 1 minute for the cell phone to register the signal coming from the Base Unit.
5. If the signal meter shows improvement, your zBoost® unit is working properly.

Note

Cell phone signal bars are approximate and vary from phone to phone. The number of bars can fluctuate widely, depending on the location of the phone, the position or angle of the phone, weather, etc. Most cell phone signal meters update every 6 to 10 seconds. An increase of only one bar typically indicates a 4x to 10x signal increase.

THE BEST INDICATOR OF PRODUCT PERFORMANCE IS THE ABILITY TO RELIABLY PLACE AND RECEIVE CALLS WHERE YOU COULD NOT BEFORE SETTING UP THE YX545 SOHO.

Improving Your Coverage Area

When your zBoost® system is in place and fully connected, you should walk throughout the room and see that you are able to reliably place calls.

Remember, coverage varies based on outdoor signal level, building construction, and antenna placement. Coverage in adjoining rooms (next to, above, or below) will be reduced due to walls or ceiling/floors.

Should you desire to improve coverage, you may:

- Relocate the Signal Antenna in order to capture a better signal –higher is usually better and outside is better than inside.
- Increase the distance between the Base Unit Antenna and the Signal Antenna.
- Purchase an upgrade antenna available at www.Wi-Ex.com

NOTE: The zBoost® YX545 SOHO requires at least 15 feet of vertical separation between the Base Unit and the Signal Antenna. Generally, increasing this distance (up to 40 feet) will increase the performance and decreasing the distance will limit zBoost® performance. (If 15 feet of separation is not possible, you may try our new METRO model, which was designed for lofts and urban dwellings and requires no vertical separation.) Keep the Base Unit off the floor and at least 2 feet away from other cords, metal objects or other wireless devices such as wireless routers or wireless access points. The zBoost® SOHO performs best when there are no obstructions between the zBoost® Base Unit and your mobile device.

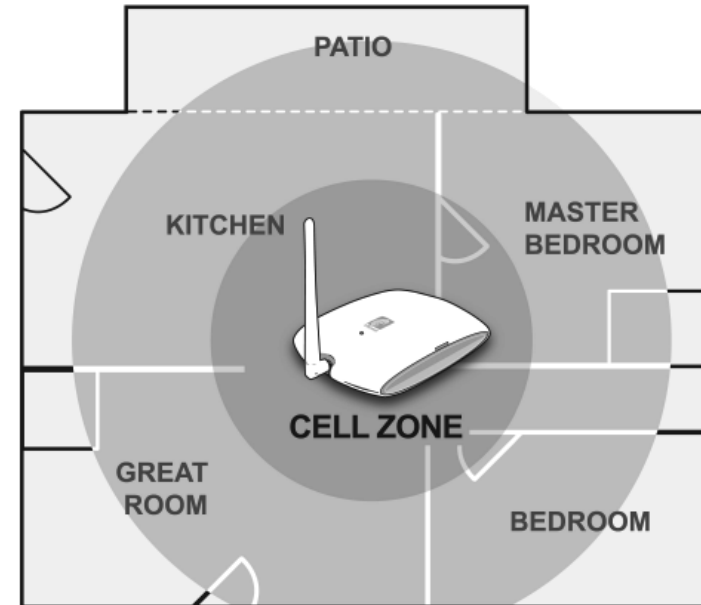

zBoost® Base Unit Light Indicators

At Initial Power Up Only

Solid GREEN	Normal condition at power up.
Slowly Alternating RED and GREEN	zBoost® is working, but at reduced performance and coverage due to “non-ideal” setup. Solution: Increase the distance between antenna and amplifier to achieve maximum performance and coverage.
Fast Flashing RED	Indicates insufficient distance between the antenna and the amplifier. The amplifier is operating at significantly reduced coverage. Solution: Increase space between base unit and antenna.
Solid RED	System is receiving signals from either the mobile device or the base station transceiver which are too strong for proper operation. Solutions: ① Move away from receiving antenna with your cell phone. ② Move antenna away from other devices..
Fast Alternating RED and GREEN followed by no light	The amplifier is disabled. Solution: Unplug and start over.

After Initial Power Up

Solid GREEN	Normal condition.
Solid RED	System is receiving signals from either the mobile device or the base station transceiver which are too strong for proper operation. Solution: Please unplug your system. Re-orient your Signal Antenna and/or Base Unit to reduce the excessive signal source. Plug your system back in. If still solid red, call customer support 1-800-871-1612.

Technical Specifications

Product Specifications for zBoost® YX545 SOHO – Dual Band

PCS band	
Frequency	Uplink: 1850 to 1910 MHz Downlink: 1930 to 1990 MHz
System Gain	60dB
PCS band supported	A, D, B, E, F, C
Networks	CDMA, GSM, GPRS, EDGE, EVDO, 1xRTT, UMTS, HSPA, 3G

Cellular band	
Frequency	Uplink: 824 to 849 MHz Downlink: 869 to 894 MHz
System Gain	60dB
CEL band supported	A, B, A', B'
Networks	CDMA, GSM, GPRS, EDGE, EVDO, 1xRTT, UMTS, HSPA, 3G

General	
Power Consumption – Power Supply Current	3W standby; 7W max signal - 5.0VDC, 2.0A Max
Wall Supply Input ; Voltage	100-240VAC, 50-60 Hz
System Certifications	FCC Parts 15 & 24 (PCS), Parts 15 & 22 (CEL), Industry Canada
Base Unit Size and Weight	5” x 7” x 1.25” – 9 oz.
Operating Conditions	Indoor Use Only (40° - 105° F)

This product uses patented technology to protect the carrier network

This product is covered by patent US 7,706,744. Other U.S. and foreign patents pending.

Frequently Asked Questions

What can I expect my cell phone signal range and strength to be inside my home or office?

The closer you are to the base, the stronger the signal. This will vary with different conditions. Some of the conditions that will affect the improved coverage area are signal strength outdoors, the type of building materials in the home, the placement of the unit and the antenna's proximity to cellular towers.

You can expect that your indoor coverage will be improved. You will be able to make calls where you couldn't before. The degree of improvement will depend upon many factors. The intent of zBoost® products are to bring outside coverage inside. Just as the signal bars move up and down when outside, the boosted signal will fluctuate in a similar fashion.

Is a cellular phone signal booster the same as a wireless router; will it help my WiFi signal?

The Wi-Ex® unit will not help your WiFi service. This unit is designed to work with wireless PCS and Cellular phones and devices. The WIFI in your home or office operates on a different frequency.

Is your product available for international use?

Yes, we have products that work on European frequencies. Our zBoost® YX520-I- Dual band works on 900MHz and 1800Mhz.

We also sell zBoost® ONE YX400-U for UMTS/HSPA devices on the 2100MHz Frequency, a frequency used for voice and data overseas.

Why isn't my cell phone indicating more signal with more bars?

You may not always observe more bars that gain on your signal meter because of the signal spreading out from the antenna. If your phone has a dB meter, 3dB is a significant increase of 2x, 6dB is 4x, and 10dB is 10x. On a four bar phone, one "bar" equals about 10dB.

The increase in signal you will see depends upon:

- The level of signal at the Signal antenna (outdoor)
- The care of the antenna placement (two feet away from metal, adequate antenna separation [15 feet recommended])
- The signal already present inside (related to building losses)
- The distance of your phone/device from the Base Unit (signal spreads or diminishes rapidly with distance.)

There are usually several cell phones in use at one time in my home, will your product boost all of our signals simultaneously?

The zBoost® YX545 SOHO is designed to cover multiple signals simultaneously and will allow multiple users to operate at the same time.

Does the zBoost® work if you have no bars?

No, if no signal is present outdoors zBoost® products will not work for you. Also, keep in mind if your best signal is 1 bar at the Signal Antenna, your coverage will be limited to a small room. You could improve that with an upgraded antenna. (See page iv).

Warranty Information

Limited 1 Year Warranty

Register your product at www.Wi-Ex.com

Wi-Ex® warrants every Wi-Ex® product to be free from defects in material and workmanship under normal use for the warranty period of one year.

Who Is Covered?

You must have proof of purchase to receive warranty service. A sales receipt or other documentation showing the product purchased and the purchase date is considered proof of purchase. This limited warranty extends only to the original consumer purchaser or any person receiving the product as a gift from the original consumer purchaser and to no other purchaser or transferee. This warranty does NOT extend to commercial users.

What is Covered?

Warranty coverage begins the day you purchase the product. For one year from the original date, the Wi-Ex® Cell Phone Signal Booster will be repaired or replaced with a new, repaired, refurbished or comparable product (whichever is deemed necessary by Wi-Ex®) if it becomes defective or inoperative. The exchange will be made without charge to you for parts and labor. You will be responsible for the cost of shipping to the location designated by Wi-Ex®.

All products, including replacement products, are covered only for the original warranty period. When the warranty on the original product expires, the warranty on the replacement product also expires.

What is Excluded?

Your warranty does NOT cover:

- Labor charges for set up of the unit.
- Product replacement because of misuse, accident, lightning damage, unauthorized repair or other cause not within the control of Wi-Ex®.
- Incidental or consequential damages resulting from the product. Some states do not allow the exclusion of incidental or consequential damages, so the above exclusion may not apply to you.
- Any modifications or other changes to the product, including but not limited to software or hardware modifications in any way other than as expressly authorized by Wi-Ex® will void this limited warranty.
- Product that has been modified or adapted to enable it to operate in any country other than the country for which it was designed, manufactured, approved and/or authorized, or repair of products damaged by these modifications.

Make sure you keep...

Please keep your sales receipt or other document showing proof of purchase. Attach it to this User Guide and keep both nearby. Also, keep the original box and packing material in case you need to return your product.

Before requesting repair service...

If red light is on, system is receiving signals from either the mobile device or the base station transceiver which are too strong for proper operation. Please unplug your system. Re-orient your Signal Antenna and/or Base Unit to reduce the excessive signal source. Plug your system back in. If still solid red, call customer support 1-800-871-1612.

To get warranty service...

Warranty service will be provided by Wi-Ex®. If you believe you need service for your unit, contact Wi-Ex® at 1-800-871-1612 or support@wi-ex.com. A representative will go through a diagnostic checklist with you. If it is determined that the product needs to be returned for service or exchanged, you will receive a return merchandise authorization (RMA) number. The representative will give you complete shipping details. Do not return products to Wi-Ex® without a Return Authorization Number (RMA).

To get out of warranty service...

To obtain out of warranty service, contact Wi-Ex® at 1-800-871-1612 or support@wi-ex.com for information on the possibility of any costs for repair or replacement of out-of-warranty products.

Reminder

Record the model and serial number found on the product below:

Model #: _____

Serial #: _____

Purchase Date: _____